

CHAPTER 2

Den Ceremonies

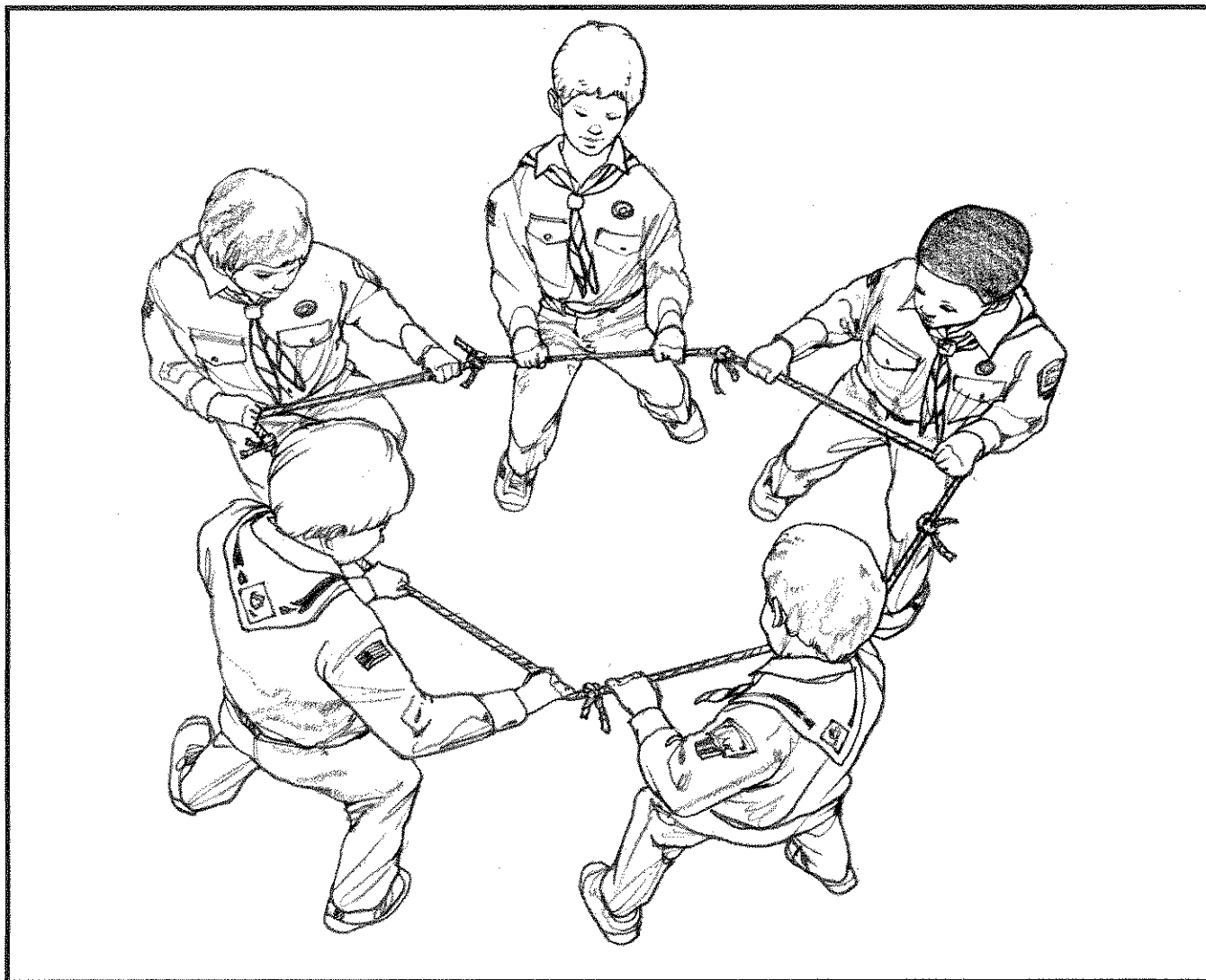

Why Do We Have Den Ceremonies? 2-2

Ceremonies

Handshake Opening, 2-2

Tiger Cub Roll Call Opening, 2-2

Cub Scout Promise Opening, 2-2

Tiger Cub Echo Opening, 2-2

Orange Bead Recognition, 2-2

White Bead Recognition, 2-2

Tiger Cub Closing, 2-3

Tiger Cub Closing Song, 2-3

Cub Scout/Webelos Scout Light, 2-3

Opening/Closing Song Ceremony, 2-3

Hike Preparation, 2-3

Pledge of Allegiance Opening, 2-3

Roll Call Opening, 2-3

Den Flag Opening, 2-3

Law of the Pack/Scout Law Opening, 2-3
 Cub Scout Promise/Boy Scout Oath Opening, 2-3
 Cub Scout/Boy Scout Motto Opening, 2-3
 Den Yell Opening, 2-3
 Cub Scout Shirt Bobcat Recognition in Den, 2-3
 Snowflake Instant Recognition, 2-4
 Den Doodle for Achievement, 2-4
 Instant Recognition Balloons, 2-4
 Instant Recognition Fishing, 2-4
 Denner and Assistant Denner Installation, 2-4
 Denner and Cub Scout Stamp Installation, 2-4
 Brotherhood Circle Closing, 2-4
 Handshake Closing, 2-4
 Leader's Minute, 2-5

Flag Folding Closing, 2-5
 Den Yell Recognition Ceremony, 2-5
 Friendship Circle Closing, 2-5
 Grand Howl Recognition Ceremony, 2-5
 Living Circle Closing, 2-5
 Meaning of the Cub Scout Promise
 or Boy Scout Oath Closing, 2-5
 Mountain Climbing Closing Thought, 2-5
 My Flag Closing, 2-5
 Patriotic Song Closing, 2-5
 Square Knot Closing, 2-5
 We Meet as Cub Scouts Closing, 2-5
 Den Doodles, 2-6

Why Do We Have Den Ceremonies?

When ceremonies are used in dens, boys have the opportunity to really understand what is happening because they play an active part.

- A flag ceremony or patriotic opening helps them learn about their American heritage.
- Installing a boy as a denner helps him learn that responsibilities come with a title and his leadership is important to the den.
- Immediate recognition toward advancement inspires other boys to work with their families on achievements.
- Opening and closing ceremonies mark the beginning and end of the den meeting and encourage appropriate behavior during the meeting.

Variety is as important as length. Den ceremonies should be kept short (no longer than two or three minutes). Use the planning forms, Tiger Cub Den Meeting Program, Cub Scout Den Meeting Program, or Webelos Den Meeting Program, to plan your ceremonies. Remember to keep them simple and effective.

Handshake Opening

The denner calls the roll, and each member of the den comes forward and gives him the Cub Scout handshake. Webelos Scouts could give the Scout handclasp.

Tiger Cub Roll Call Opening

As the den meeting host calls roll, each Tiger Cub team responds with a loud tiger growl.

Cub Scout Promise Opening

The Tiger Cubs form a large circle. Their adult partners form an outer circle by standing behind their Tiger Cubs. All say the Cub Scout Promise in unison.

Tiger Cub Echo Opening

ADULT PARTNERS: Search!

TIGER CUBS: Search!

ADULT PARTNERS: Discover!

TIGER CUBS: Discover!

ADULT PARTNERS: Share!

TIGER CUBS: Share!

Orange Bead Recognition

Preparation: Put orange activity beads in a cloth pouch. The narrator is the adult partner who is hosting the meeting. The narrator's Tiger Cub distributes the beads.

NARRATOR: Today, we experienced the fun of completing a den meeting requirement for the Tiger Cub badge. In recognition of today's activity, an orange bead will be added to your Tiger Cub Immediate Recognition Emblem. *(The narrator's Tiger Cub partner distributes one orange bead to all the adult partners. The adult partners attach the beads to the boys' totems.)*

White Bead Recognition

Preparation: Put white beads in a small box decorated to look like a treasure chest.

NARRATOR: Today, we would like to present a special bead from our den treasure chest to the Tiger Cubs who have completed a Tiger Cub rank requirement with their families. Tiger Cub [Name] and his adult partner please step forward. This Tiger Cub and his family have complet-

ed a required activity together. (*Ask the boy to tell about the activity.*) As a memento of the treasure of time your family spent together, I am presenting a white bead to your adult partner to attach to your Tiger Cub Immediate Recognition Emblem. (*Lead the den in the den cheer or a tiger growl.*)

Tiger Cub Closing

The Tiger Cubs and their adult partners stand in a circle and hold hands. In turn, each adult partner tells one thing his Tiger Cub did since the last meeting to search, discover, or share. End with everyone reciting the Cub Scout Promise.

Tiger Cub Closing Song

Tiger Cubs and their adult partners stand in a circle and sing the following closing song:

Have Fun Tigers
(*Tune: "Good Night Ladies"*)

Have fun, Tigers.
Have fun, Tigers.
Have fun, Tigers.
Search, discover, 'n' share.

Merrily we do all three,
Do all three, do all three.
Merrily we do all three,
Search, discover 'n' share.

Cub Scout/Webelos Scout Light

The den leader asks den members to sit on the floor in a circle and dims the lights. Have a small candle and larger candle, plus matches, on a table.

DEN CHIEF: I will light this small candle. It represents the goodwill given by one Cub Scout [or Webelos Scout]. See how it shines? The rays from several Cub Scouts [Webelos Scouts] make a brighter light. Each Scout lets his light shine by doing his best and helping other people.

DEN LEADER: I'll light this large candle. This represents that there is a brighter light that leads us all. Let us always think first of God, second of others, and finally of ourselves.

Opening/Closing Song Ceremony

Select a song from the *Cub Scout Songbook* to sing as your opening or closing. You might also select a song related to the monthly theme or Webelos activity badge to sing as the opening or closing ceremony.

Hike Preparation

Have the boys gather in a circle. Proceed around the circle. Each boy should list what has already been said and end with his item.

DEN LEADER: Pretend you are preparing for a hike. Think about something you would need to take with you. Listen to what each person is bringing; list everyone's items, and add yours to the end of the list. (*Proceed around the circle until each boy has had his turn.*) When you are prepared, you can live up to the Cub Scout motto. Will you Do Your Best? (*Webelos den leader could ask, "Will you Be Prepared?"*)

BOYS: We'll Do Our Best. (*Webelos Scouts can say, "We'll Be Prepared."*)

Pledge of Allegiance Opening

The den gathers in a semicircle or horseshoe formation. One boy presents the colors (the U.S. flag) at the open end of the horseshoe. In turn, each boy steps forward, gives the Cub Scout salute, and steps back. Follow with the Pledge of Allegiance.

Roll Call Opening

The denner calls roll, and the boys respond by naming an item related to the theme or activity badge for the month.

Den Flag Opening

The den forms a tight circle with the den flag in the center. Each boy grasps the flagstaff with his left hand, makes the Cub Scout sign with his right hand, and says the Cub Scout Promise.

Law of the Pack/Scout Law Opening

The den forms a circle, gives the Cub Scout salute, and says the Law of the Pack. [Webelos Scouts give the Scout salute and say the Scout Law.]

Cub Scout Promise/Boy Scout Oath Opening

Select a phrase from the Cub Scout Promise and talk about its meaning. [Webelos Scouts discuss a phrase from the Boy Scout Oath.]

Cub Scout/Boy Scout Motto Opening

Talk about the meaning of the Cub Scout motto. Say it in unison. [Webelos Scouts talk about the meaning of the Boy Scout motto and say it in unison.]

Den Yell Opening

Give your den yell.

Cub Scout Shirt Bobcat Recognition in Den

Preparation: Cut a piece of blue cardboard into the size and shape of a Cub Scout shirt with pockets on it and a hand-drawn version of the Bobcat badge (or a Bobcat badge sticker).

DEN LEADER: This Cub Scout shirt is very plain and could belong to anyone. It represents a sense of belonging and friendship in our den. Once you place the Bobcat badge on this shirt, it shows that our Scout has new knowledge and skills. Today, we have some den members who have earned this special recognition. Congratulations!

Snowflake Instant Recognition

Preparation: Cut out paper snowflakes and hang an instant recognition bead from each one.

DEN LEADER: Snowflakes begin to appear one at a time, and each one takes its own form. Will [den member] please come forward. (*Present the snowflake.*) With each of you working on achievements, we will soon make a snowstorm out of our snowflakes. All of us can encourage one another!

Den Doodle for Achievement

Preparation: Have a bead or other object ready to be attached to the den doodle for each boy or achievement that will be recognized. After all achievements are presented, the den leader says the achievement pledge, and the den members repeat it, line by line.

DEN LEADER: We have a boy (or boys) ready to add an achievement to his (or their) string on the den doodle. He has (or they have) been working hard and completed an achievement (or activity badge) toward his Wolf (or Bear or Webelos) badge. Congratulations, [Name]! Keep up the great work! (*Present him with a bead or other object to attach to his area on the den doodle.*) While he is adding this to his string, let's repeat our den achievement pledge:

We, the boys of den [number], (*Boys repeat.*)
Promise to do our best, (*Boys repeat.*)
To keep working on our achievements, (*Boys repeat.*)
And really pass the test. (*Boys repeat.*)

Instant Recognition Balloons

Put instant recognition beads inside balloons and then blow up the balloons. Let the boys pop the balloons to receive their instant recognition.

Instant Recognition Fishing

Make a fishing pole from a stick and string and attach a magnet for the hook. Attach a paper clip or a pin to the instant recognition beads. Have the boys fish for their awards.

Denner and Assistant Denner Installation

Preparation: Set a white candle and matches to light it where everyone can see it. Have a denner shoulder cord ready to present to the chosen boy.

DEN LEADER: Cub Scout/Webelos Scout [Name of new denner], will you please step forward and light our can-

dle. (*The denner lights the candle.*) This white candle represents the spirit of Scouting. It takes team effort to keep the spirit alive—to keep the candle burning. You have just been elected to be a member of that team.

As denner, your duties are to assist our den. You will help record attendance and collect den dues. (*These duties may vary depending on the den.*)

During the week, you will set a good example for the other members of our den by being honest and fair, and showing true Scouting spirit.

Do you accept these responsibilities?

DENNER: I will do my best.

DEN LEADER: I'm happy to present to you the denner cord, which is to be worn on your left sleeve during your term of office. Wear it proudly and with honor. Congratulations!

Cub Scout/Webelos Scout [Name] has been selected to be our assistant denner. His duty will be to help our denner in his duties. Do you accept your responsibilities?

ASSISTANT DENNER: I will do my best.

DEN LEADER: We present to you the assistant denner cord that is to be worn on your left sleeve during your term of office. Congratulations!

Denner and Cub Scout Stamp Installation

Preparation: Secure a rubber stamp with the Cub Scout symbol on it and a washable ink stamp pad. Have a denner shoulder cord ready to present to the chosen boy.

DEN LEADER: (*Stamp the right band of the new denner.*) As our denner, you will have the responsibility of assisting our den chief and me. Will you do your best to help our den along the achievement trail and share with them the work and fun of Scouting?

DENNER: I will do my best. (*Present the denner cord.*)

Brotherhood Circle Closing

Preparation: Form the den in a brotherhood circle: Each boy places his left arm around the shoulder of the boy on his left and his right arm around the shoulder of the boy on his right.

DEN LEADER or DEN CHIEF: Now may the Great Master of all Scouts be with us until we meet again.

Handshake Closing

Have the boys give the Cub Scout handshake to the den leader and den chief and then leave quietly. Another version is to have the boys form a circle and pass the handshake from one to another around the circle until it reaches the boy who started it. As each boy receives the handshake, he silently makes a wish and pledges to do his best.

Tiger Cubs and Cub Scouts use the Cub Scout handshake. Webelos Scouts use the Scout handclasp.

Leader's Minute

This is a closing inspirational thought. It can be a brief story about the Cub Scout Promise, the Scout Oath, the Law of the Pack, the Scout Law, the motto, or something patriotic. It could reflect ideals such as being kind to animals and people, showing sportsmanlike behavior, or participating in school activities. It is told without moralizing.

Flag Folding Closing

Have three boys fold the flag while the other boys stand reverently in a semicircle.

Den Yell Recognition Ceremony

Den members form a circle around the den flag. They give their den yell in honor of those den members who completed an achievement or elective this month.

Friendship Circle Closing

Den leaders and members form a friendship circle: Cross arms with right arm over left and grasp the hands of people on each side. They then sing a closing song.

Grand Howl Recognition Ceremony

Cub Scouts form a circle around the person in whose honor the grand howl is to be given. This may be a visitor, the den chief, a new den member, or a Cub Scout who has earned the respect of the "wolves." Each boy squats, makes the Cub Scout sign with both hands, and touches them to the ground between his feet. Then, like young wolves, the Cub Scouts raise their heads and give a long howl. As the last word is yelled, everyone jumps to his feet, and raising his right hand high above his head, gives the Cub Scout sign.

DEN MEMBERS: Akela! We'll—do—our—best!

Living Circle Closing

Den leaders and den members form a close circle and turn to their right, each placing his left hand into the center of the circle, palm facing downward. Each person grasps the thumb of the person behind him, making a complete circle with the group. Everyone's right hand is held straight up in the Cub Scout sign. One version is to pump joined hands up and down seven times as all say, "Akela! We'll—do—our—best!" You can also use the Cub Scout Promise, Law of the Pack, Cub Scout motto, or your own personal words in place of this chant.

Meaning of the Cub Scout Promise or Boy Scout Oath Closing

Den members form a circle, and each person says one sentence of the Cub Scout Promise and then explains what this sentence means to him. Webelos dens could use the Scout Oath.

Mountain Climbing Closing Thought

Preparation: Ask the boys to sit in a circle with the den leader and close their eyes.

DEN LEADER: Picture a very high mountain. It is beautiful but very dangerous. It has slippery glaciers and high rocky places you can climb only with special equipment and with help from other people. Mountain climbers depend on each other. They must be able to trust their friends at the other end of the rope. When you pick your friends, think about whether this is a person you could trust at the end of that rope. Let's have a moment of silence as we think about the good friends we have chosen.

My Flag Closing

Right before the ending, the den leader asks each boy to write a sentence about what the U.S. flag means to him. For the closing ceremony, read the statements.

Patriotic Song Closing

Den members form the den in a circle around the U.S. flag. Everyone salutes and sings "America," "God Bless America," or another patriotic song. (See the *Cub Scout Songbook* for ideas.)

Square Knot Closing

Preparation: Give each boy a 3-foot section of rope. The boys tie the rope with a square knot to each other's ropes to form a complete circle. They all lean back carefully to form a taut circle.

DEN LEADER: You are part of a group of close friends, held together by the square knot—a symbol of friendship.

We Meet as Cub Scouts Closing

Preparation: Have the boys form in a circle.

DEN LEADER: We meet as Cub Scouts [Tiger Cubs, Webelos Scouts], we part as friends, as now we leave, our meeting ends.

Let this circle be a token of friendship, as Akela guides us home.

Den Doodles

Many dens use a den doodle to encourage advancement. A den doodle is an emblem, figure, or other object that visually records the progress of the boys in a Tiger Cub, Cub Scout, or Webelos den. Each boy can add something to his string on the den doodle as he completes advancement requirements.

The doodles are the most fun when the boys help make them, after deciding on a theme that fits their den. No two dens make doodles that are alike. Each one is distinctive and has the den's number, a place for each boy's name, and a cord or thong for his record.

Buttons, corks, paper beads, spools, bottle tops, wooden beads, pasta, cutouts, and shells are a few of the items used as symbols of progress. Each symbol, or device, is usually identified with the name of the recognition, such as Wolf Achievement 1, and the date. The boys will look forward to hanging devices on the doodle as they complete achievements and electives and earn Webelos activity badges.

Additional symbols can be included to recognize attendance, wearing the complete uniform, remembering to bring their books to den meetings, or other desired behavior. Beads can be added to commemorate special events during the year. You are limited only by your imagination.

Doodles can be either a table model or floor model. The base can be a coffee can filled with plaster or a device designed using inexpensive plastic pipe and connectors. More examples of den doodles are found in the *Cub Scout Leader Book* and the *Cub Scout Leader How-To Book*.

When an addition is made to the den doodle, acknowledge it with a short ceremony at the den meeting. Take the den doodle to pack meetings and proudly display it next to the den flag.

Use your imagination in creating a den doodle. Scrounge for inexpensive supplies. Look for design ideas in children's coloring books or in clip-art collections. Let the boys choose the design of their den doodle.

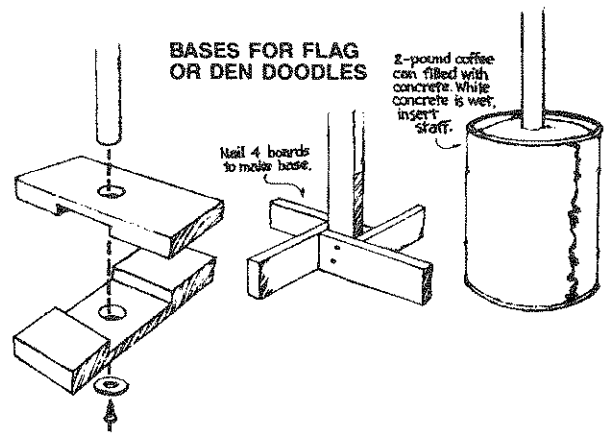

For the base of your den doodle:

1. Plan a wooden removable base.
2. Mix plaster in a coffee can, cover pole with foil and insert while plaster is wet. Let the plaster harden and then remove the covered pole.
3. Use inexpensive plastic PVC pipe and connectors to create a removable base.

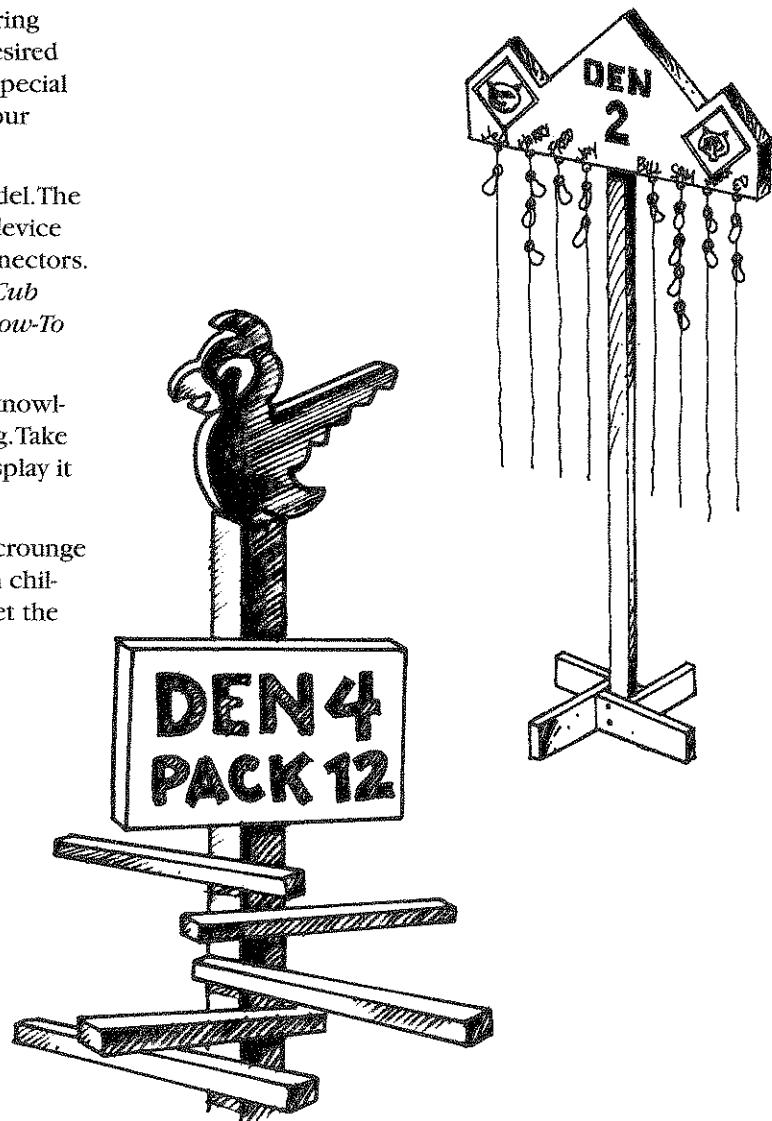

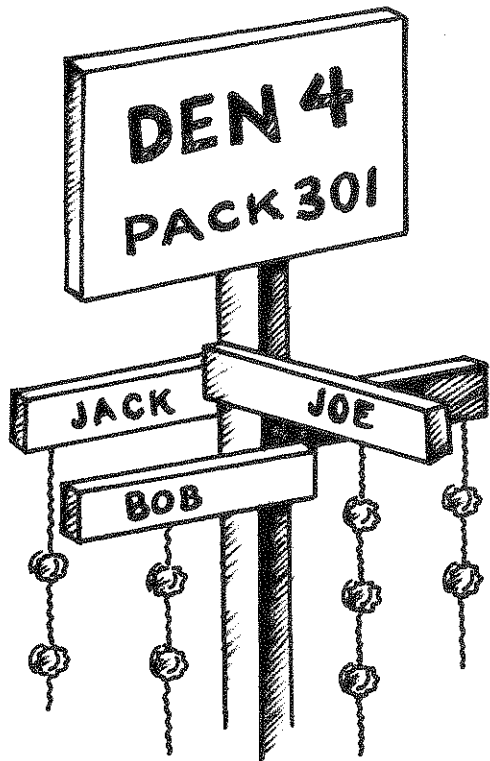

Wooden coat hanger

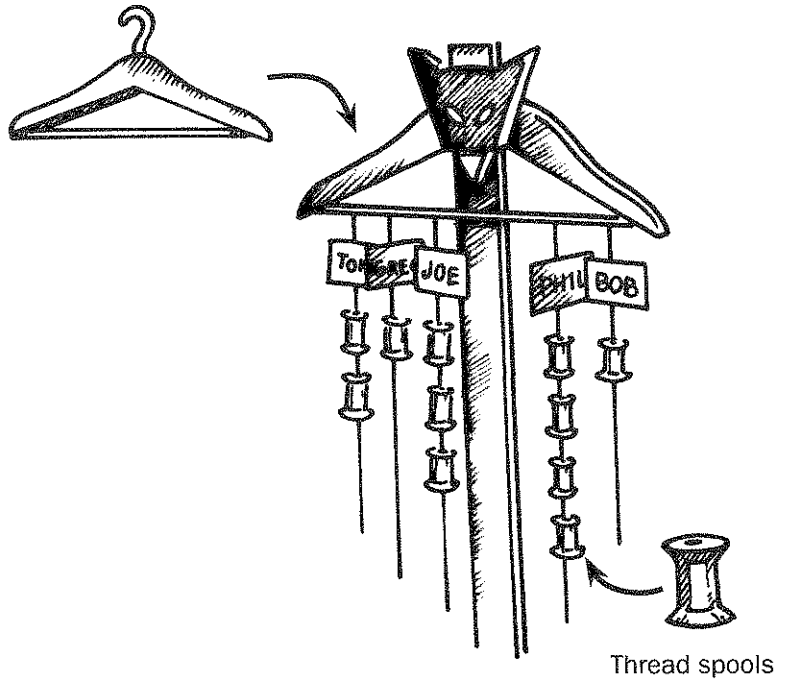

Colored cardboard or wooden disks can be added for each achievement or elective completed. Use different colors for each rank.

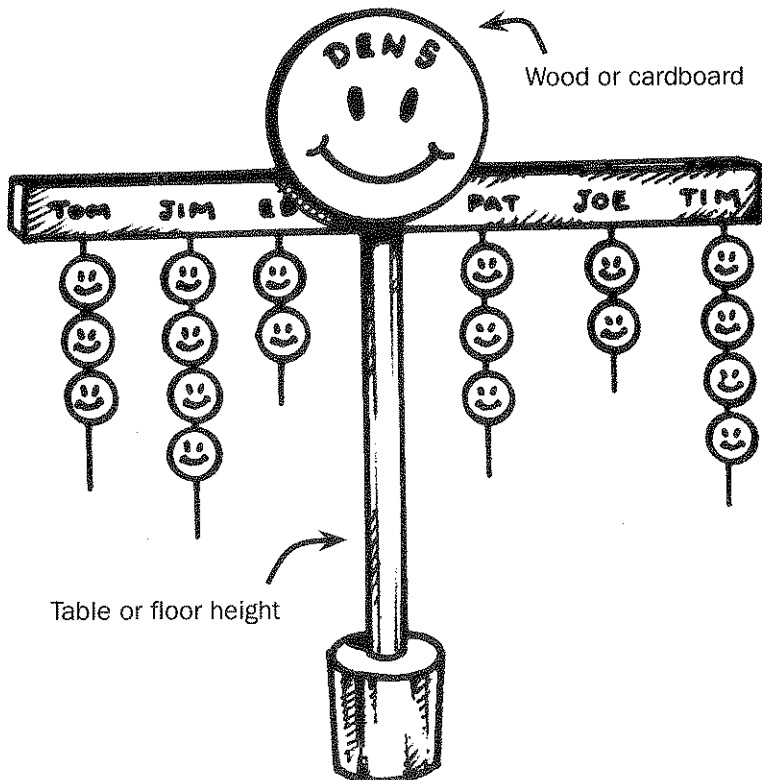

Dowel

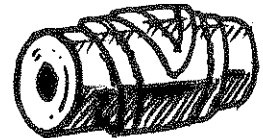
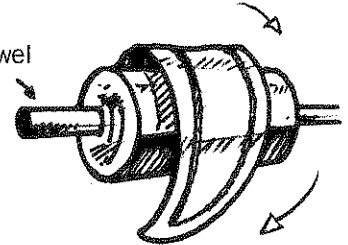

PAPER BEADS: Cut colorful magazine pages into long triangles. Dip in a thin solution of glue and water and roll on dowels. Remove from dowels and let dry. Boys love this messy job!

